

Single Post Items

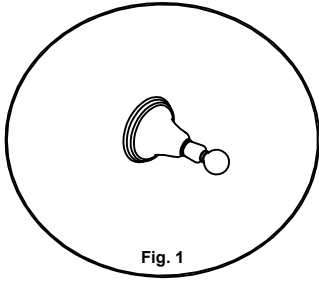

Robe Hook

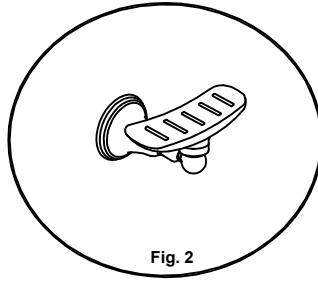

Soap Dish

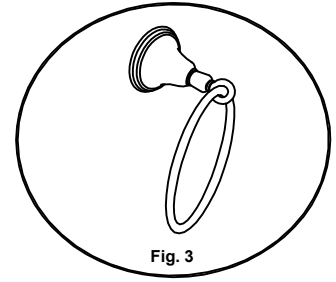

Towel Ring

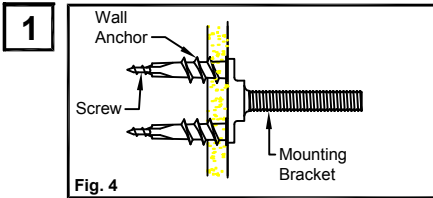

1 Install mounting bracket to wall with screws (supplied) and anchors (if applicable).

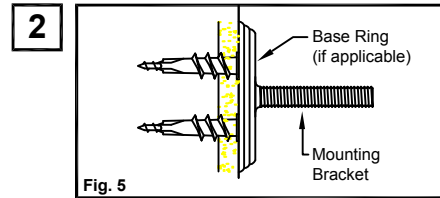

2 Place base ring (required on certain models) against wall, over the mounting bracket.

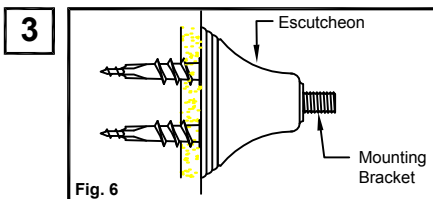

3 Place escutcheon against wall, over the mounting bracket.

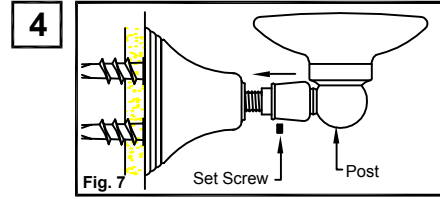

4 Set post over the wall bracket, inserting through escutcheon. Tighten set screw with allen key (supplied).

REMINDER:
Please retain allen key as posts may require periodic tightening with normal use.

Fig. 8

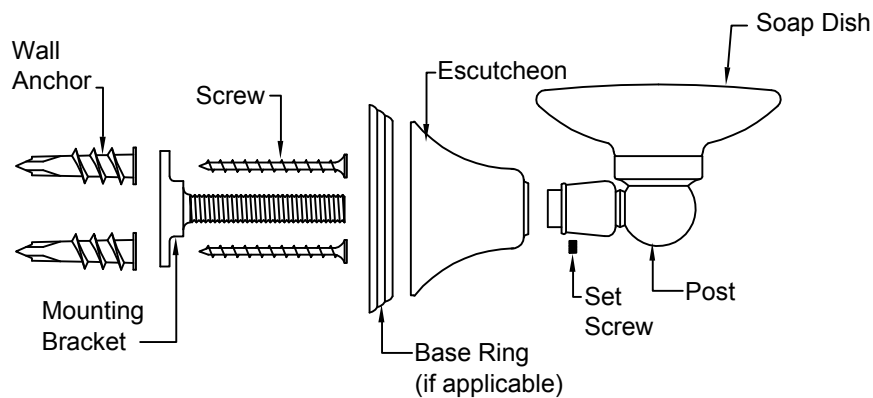

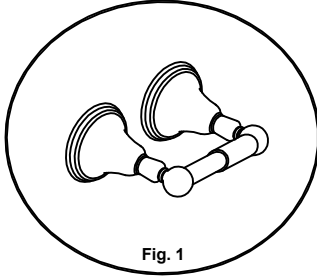

Fig. 1
Toilet Paper Holder

Dual Post Items
(For dimensions on center see Fig. 9)

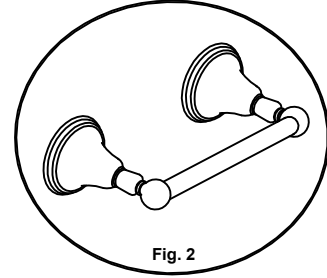
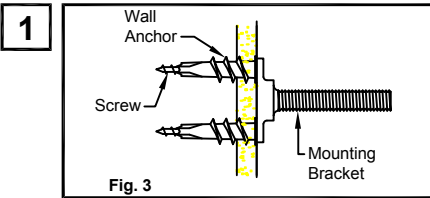
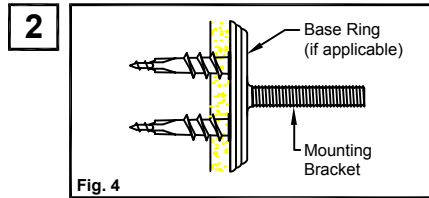

Fig. 2
Towel Bar



Install mounting brackets to wall with screws (supplied) and anchors (if applicable). (See Fig. 9 for proper centering).



Place base rings (required on certain models) against wall, over the mounting brackets.

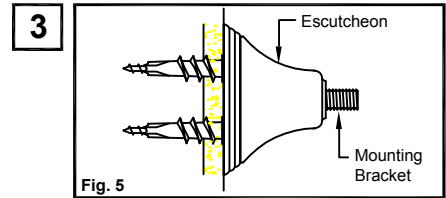

Place escutcheons against wall, over the mounting brackets.

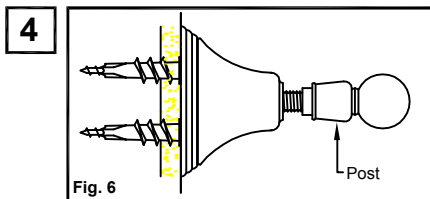

Set posts over the wall brackets, inserting through escutcheons.

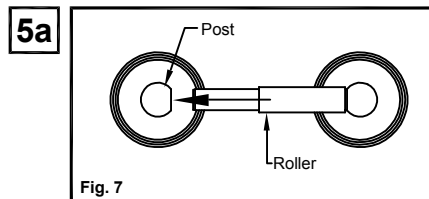

For toilet paper holder, align posts and tighten set screws with allen key (supplied). Then simply insert roller into posts.

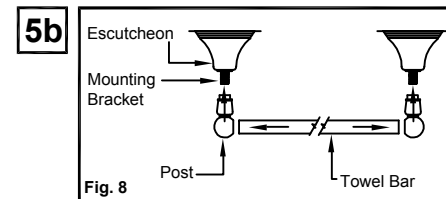

Insert towel bar into both posts and slide both posts onto the mounting bracket posts protruding from escutcheons. Then tighten both set screws from below.

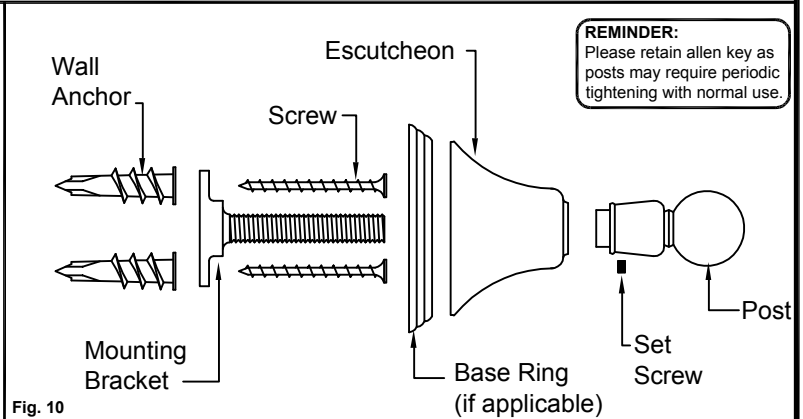
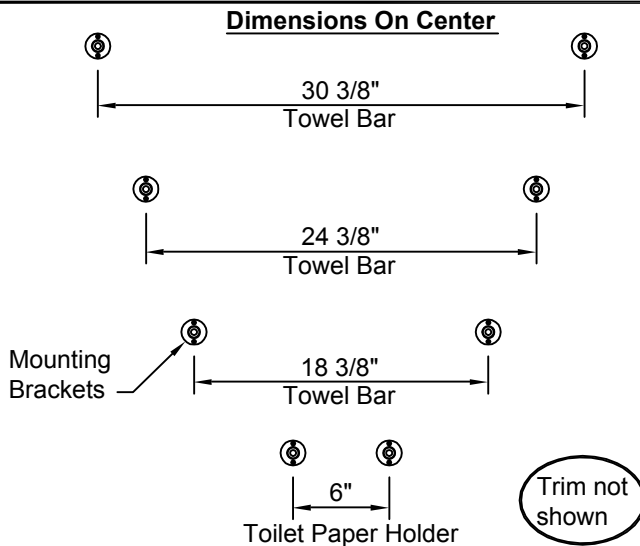

REMEMBER:
Please retain allen key as posts may require periodic tightening with normal use.

IMPORTANT CLEANING NOTICE
Please refer to *Finish Care Instructions* for complete cleaning information. Wipe frequently with a soft, damp cloth. **Never use acids, harsh abrasives or detergents.**



California Faucets®

Tel: 714-891-7797
Fax: 714-891-2478
Toll Free:
800-822-8855
www.calfaucets.com

ACCESSORIES - 22 Series

INSTALLATION INSTRUCTIONS

IMPORTANT

All California Faucets products are engineered to provide quality performance provided they are installed and operated properly. To fully enjoy the comfort, safety, and reliability of your new Accessories, please follow the instructions below.

California Faucets reserves the right to make modification and specification changes at any time. Please verify dimensions prior to installation. Visit www.calfaucets.com for most current technical data.

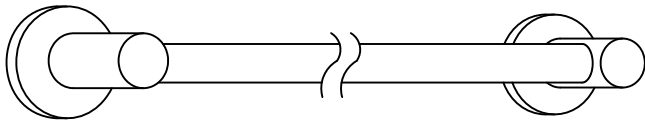

Towel Bar 18" - 24"

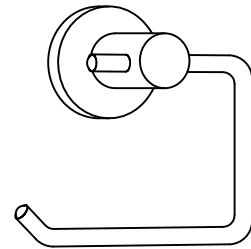

Toilet Paper Holder

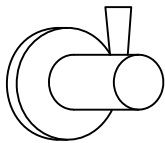

Robe Hook

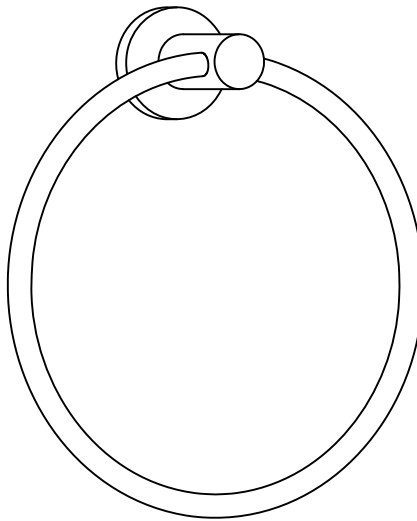

Towel Ring

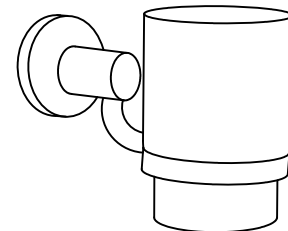

Toothbrush Holder

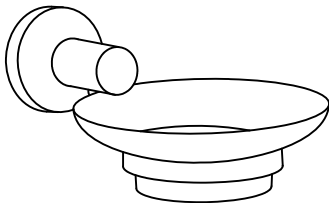

Soap Dish

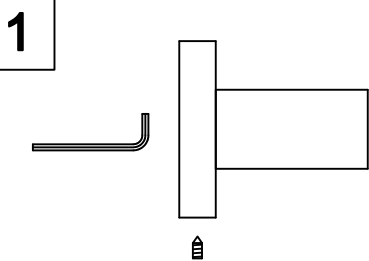

1 Loosen the set screw of the body assembly. Pull out the mounting bracket.

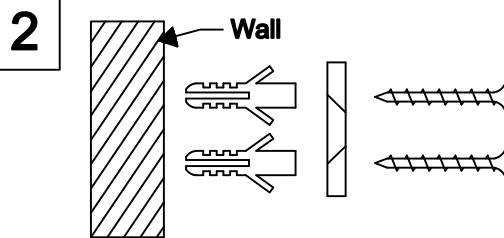

2 Install Mounting bracket to the wall with screws (supplied) and anchors (if applicable).

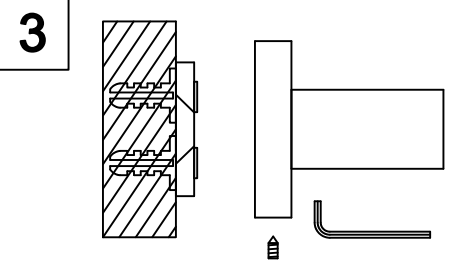

3 Slide body assembly onto mounting bracket. Tighten set screw with allen key (supplied).

NOTE: Please retain allen key as posts may require periodic tightening with normal use.

IMPORTANT CLEANING NOTICE

Please refer to *Finish Care Instructions* for complete cleaning information. Wipe frequently with a soft, damp cloth. **Never use acids, harsh abrasives or detergents.**