

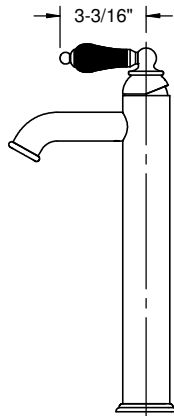

CF-3301-2-H40

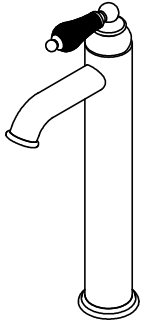

CF-3301-2-H42

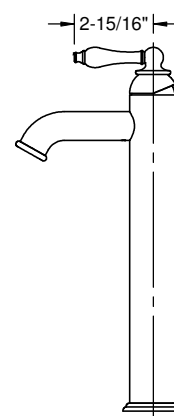
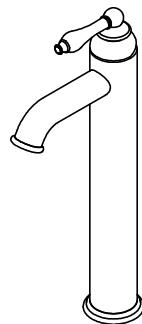

CF-3301-2-H55

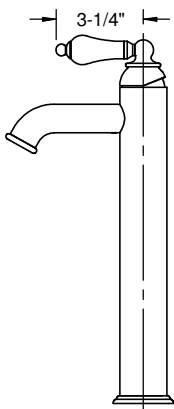
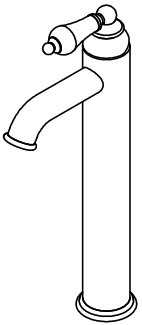

CF-3301-2-H64

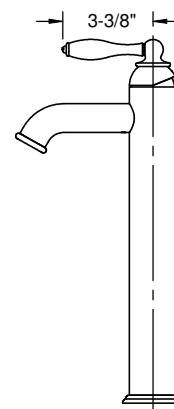
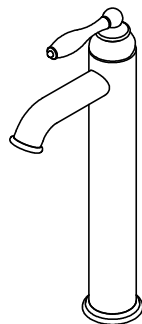

CF-3301-2-H68

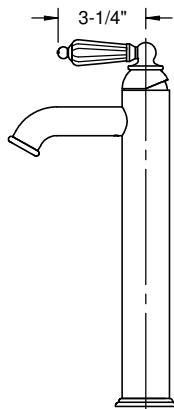
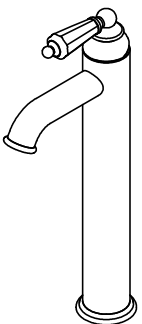

CF-3301-2-CLEV

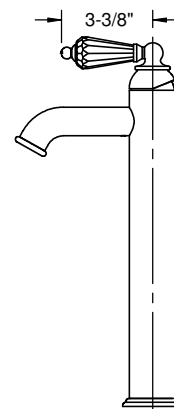
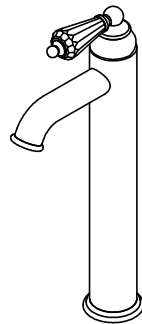

Dimensions Shown to Nearest 1/16"



Features

- Over 30 finishes including 11 PVD finishes
- All brass construction
- Single handle operation cartridge with ceramic disc
- Flexible connections for easy installation
- 4-9/16" spout reach
- Flush mount aerator insert
- Maximum flow rate: 1.5 gpm (5.7 L/m)
- See www.calfaucets.com for complete series selection

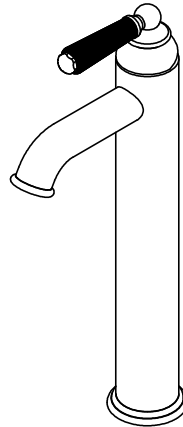

Codes/Standards Applicable

Specified model meets or exceeds the following:

- ASME A112.18.1-2005/CSA B125.1-05
- NSF 61
- ADA
- CA & VT Lead Plumbing Law

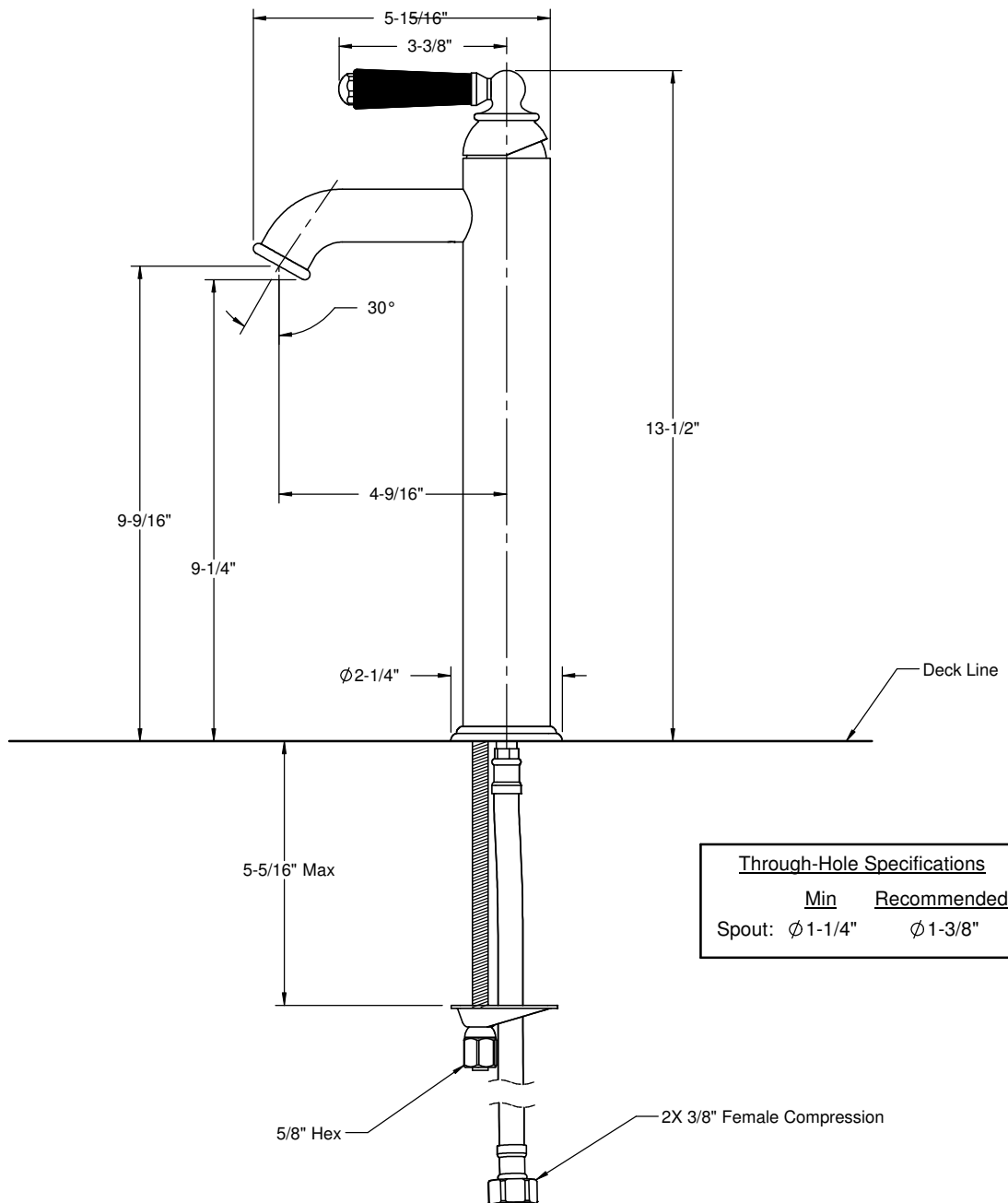

Dimensions Shown to Nearest 1/16"



CF-4201-2-H33

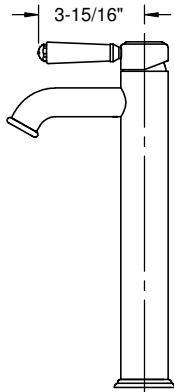
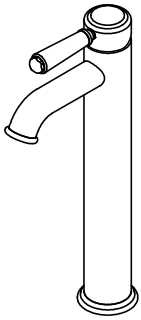

CF-4201-2-H35

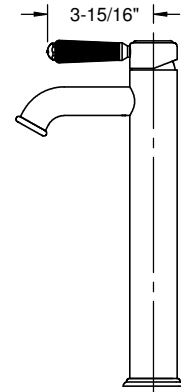
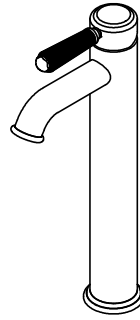

CF-4201-2-H40

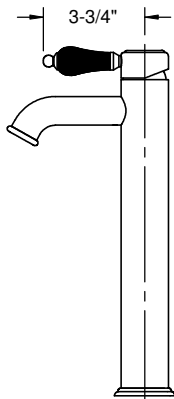
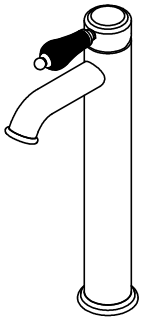

CF-4201-2-H55

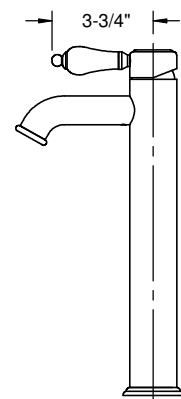
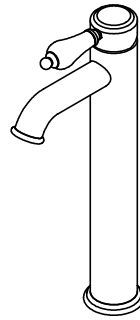

CF-4201-2-H64

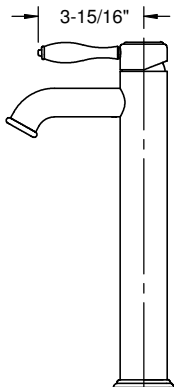
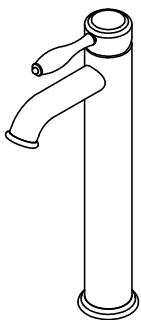

CF-4201-2-H68

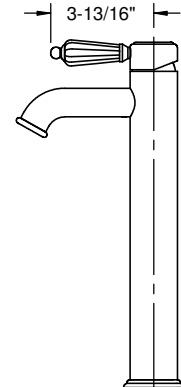
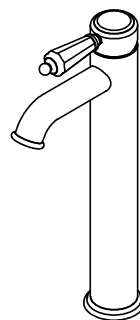

CF-4201-2-CLEV

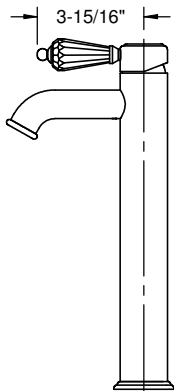
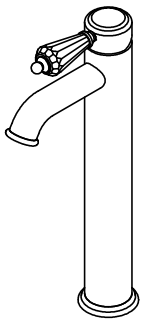

Dimensions Shown to Nearest 1/16"



Features

- Over 30 finishes including 11 PVD finishes
- All brass construction
- Single handle operation cartridge with ceramic disc
- Flexible connections for easy installation
- 4-1/2" spout reach
- Flush mount aerator insert
- Maximum flow rate: 1.5 gpm (5.7 L/m)
- See www.calfaucets.com for complete series selection

Codes/Standards Applicable

Specified model meets or exceeds the following:

- ASME A112.18.1-2005/CSA B125.1-05
- NSF 61
- ADA
- CA & VT Lead Plumbing Law

CF-6201-2

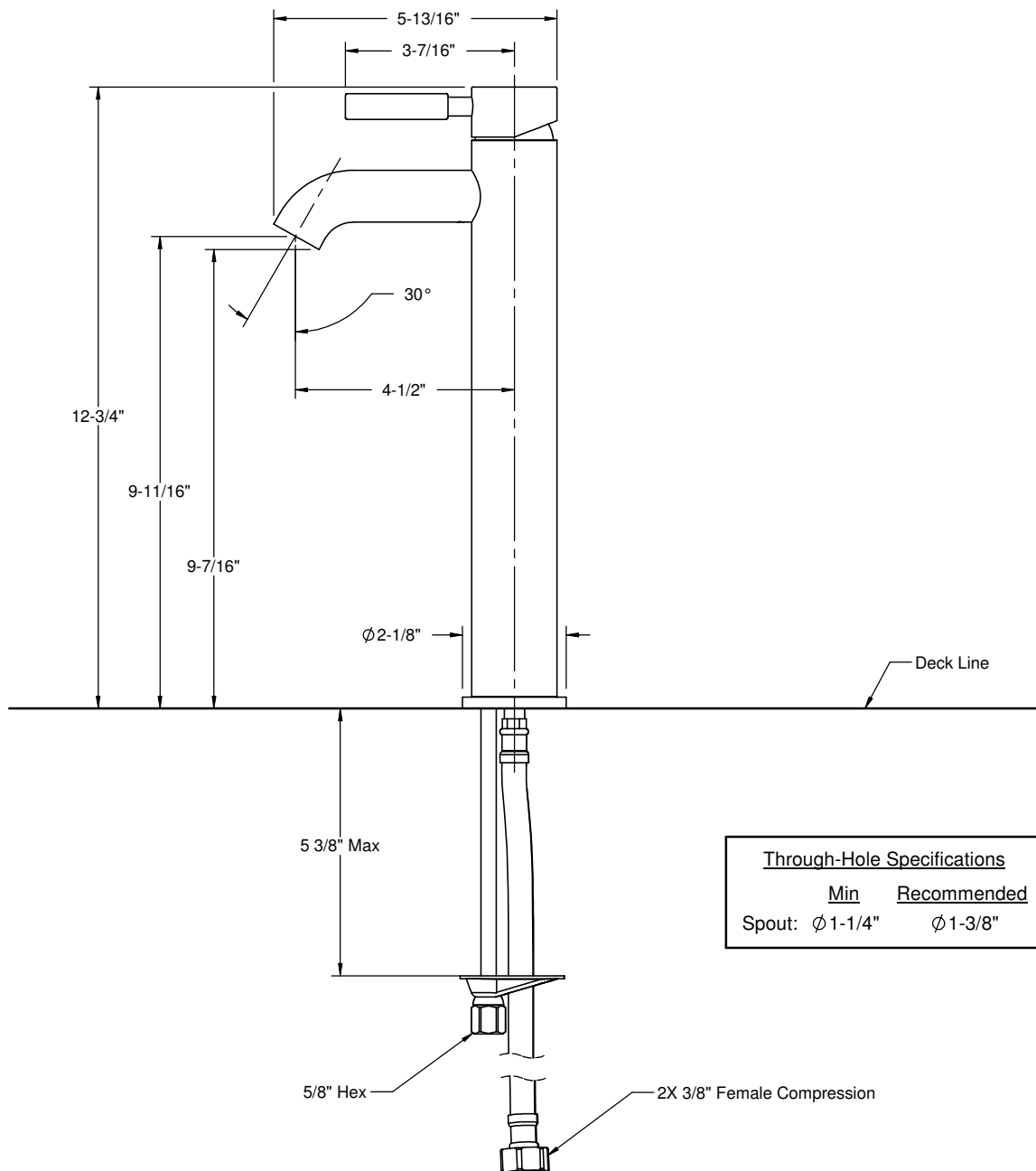
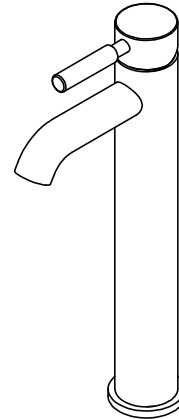

Dimensions Shown to Nearest 1/16"