



California Faucets®

Belmont™

SINGLE HOLE LAV / VESSEL / BAR FAUCET

Features

- 4-9/16" spout center to center
- Single handle operation cartridge with ceramic disc
- Flexible braided hoses for ease of installation
- Flush mount aerator insert
- 1.2 gpm (4.5 L/min) max flow rate
- Solid brass construction
- Over 30 finishes including 15 PVD finishes

Codes/Standards Applicable

Product meets or exceeds the following:

- ASME A112.18.1/CSA B125.1
- NSF/ANSI 61 & NSF/ANSI 372
- CEC
- ADA compliant

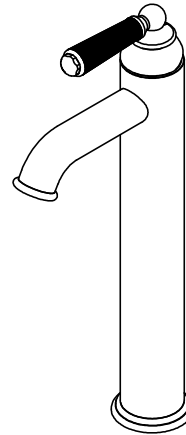

CF-3501-2



CF-3501-2-HXX (XX = Optional Series Handle)

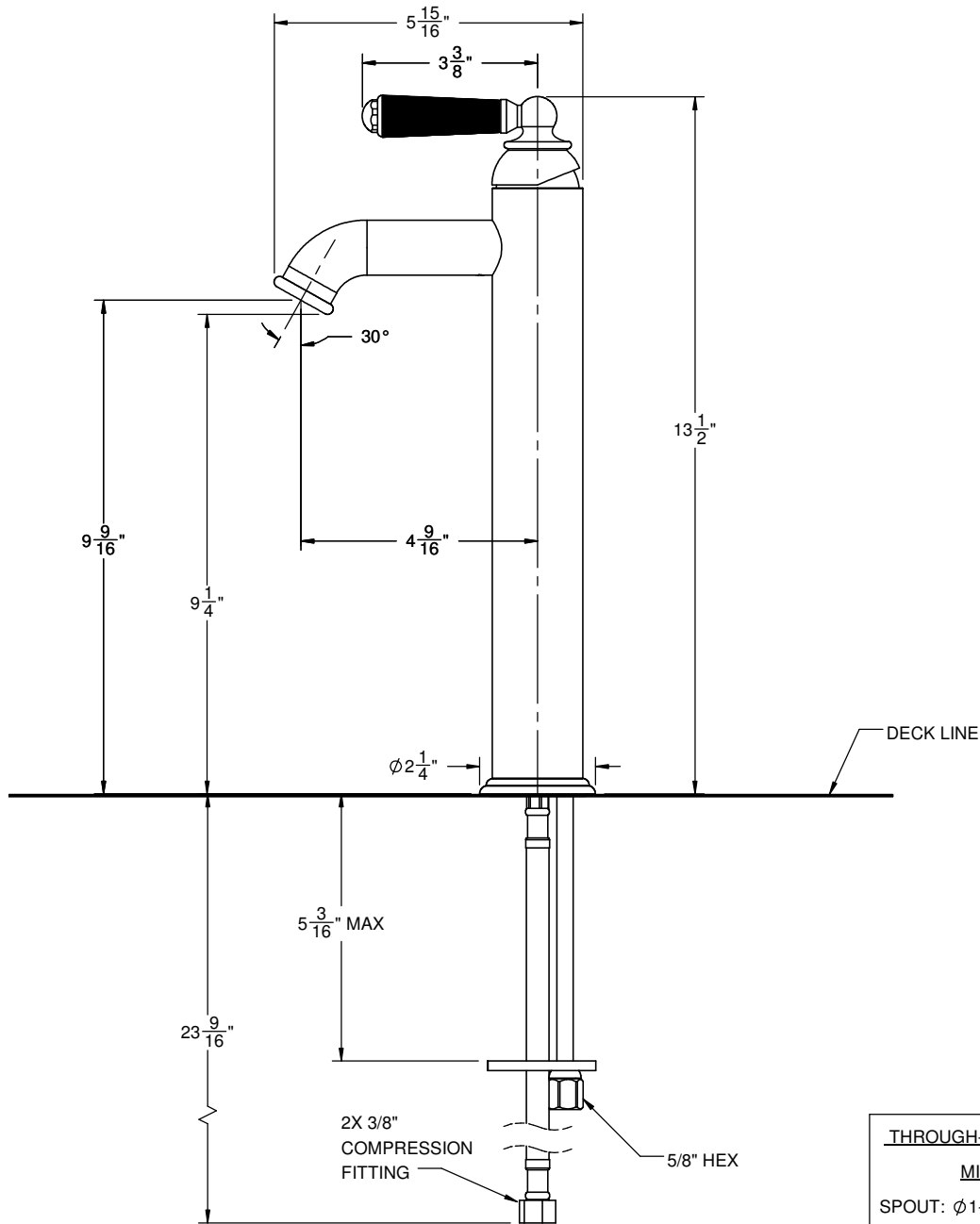

THROUGH-HOLE SPECIFICATIONS	
MIN	RECOMMENDED
SPOUT: Ø 1-1/4"	Ø 1-3/8"

ALL DIMENSIONS SHOWN TO NEAREST 1/16"



California Faucets®

Belmont™

SINGLE HOLE LAV / VESSEL / BAR FAUCET

CF-3501-2-H33

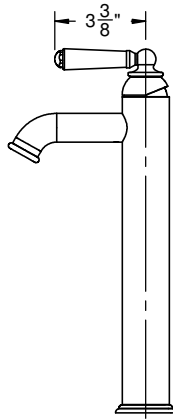
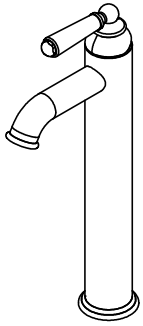

CF-3501-2-H40

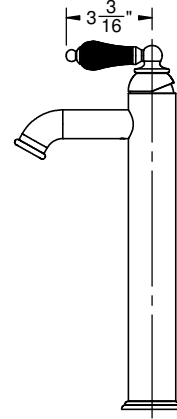
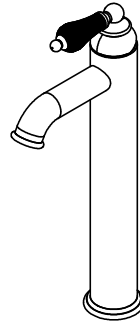

CF-3501-2-H42

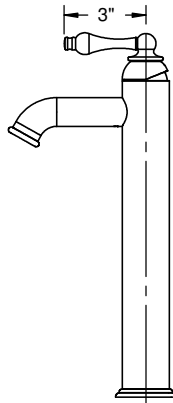
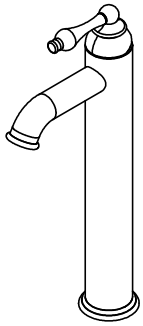

CF-3501-2-H55

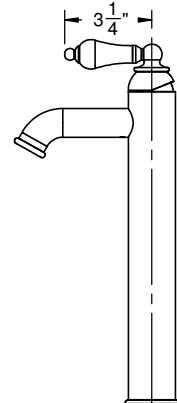
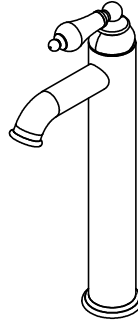

CF-3501-2-H64

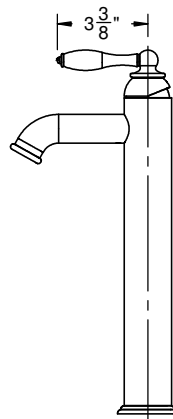
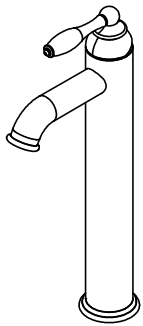

CF-3501-2-H68

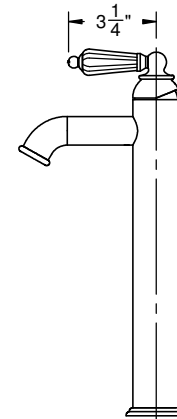
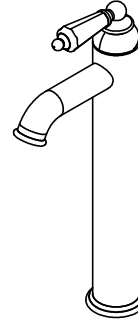

CF-3501-2-CLEV

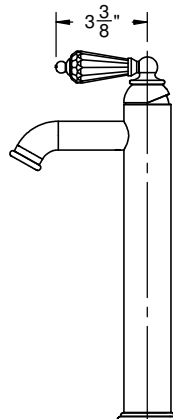
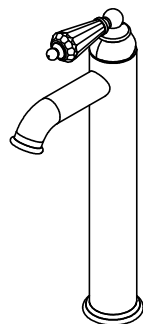

ALL DIMENSIONS SHOWN TO NEAREST 1/16"