



California Faucets®

Huntington™

SINGLE HOLE LAV / VESSEL / BAR FAUCET

Features

- 4-9/16" spout center to center
- Single handle operation cartridge with ceramic disc
- Flexible braided hoses for ease of installation
- Flush mount aerator insert
- 1.2 gpm (4.5 L/min) max flow rate
- Solid brass construction
- Over 30 finishes including 15 PVD finishes

Codes/Standards

Product meets or exceeds the following:

- ASME A112.18.1/CSA B125.1
- NSF/ANSI 61 & NSF/ANSI 372
- CEC
- ADA compliant

CF-4201-2

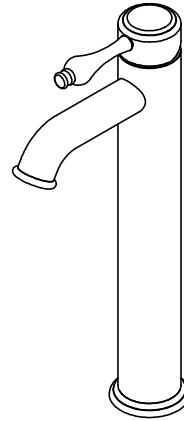

CF-4201-2-HXX (XX = Optional Series Handle)

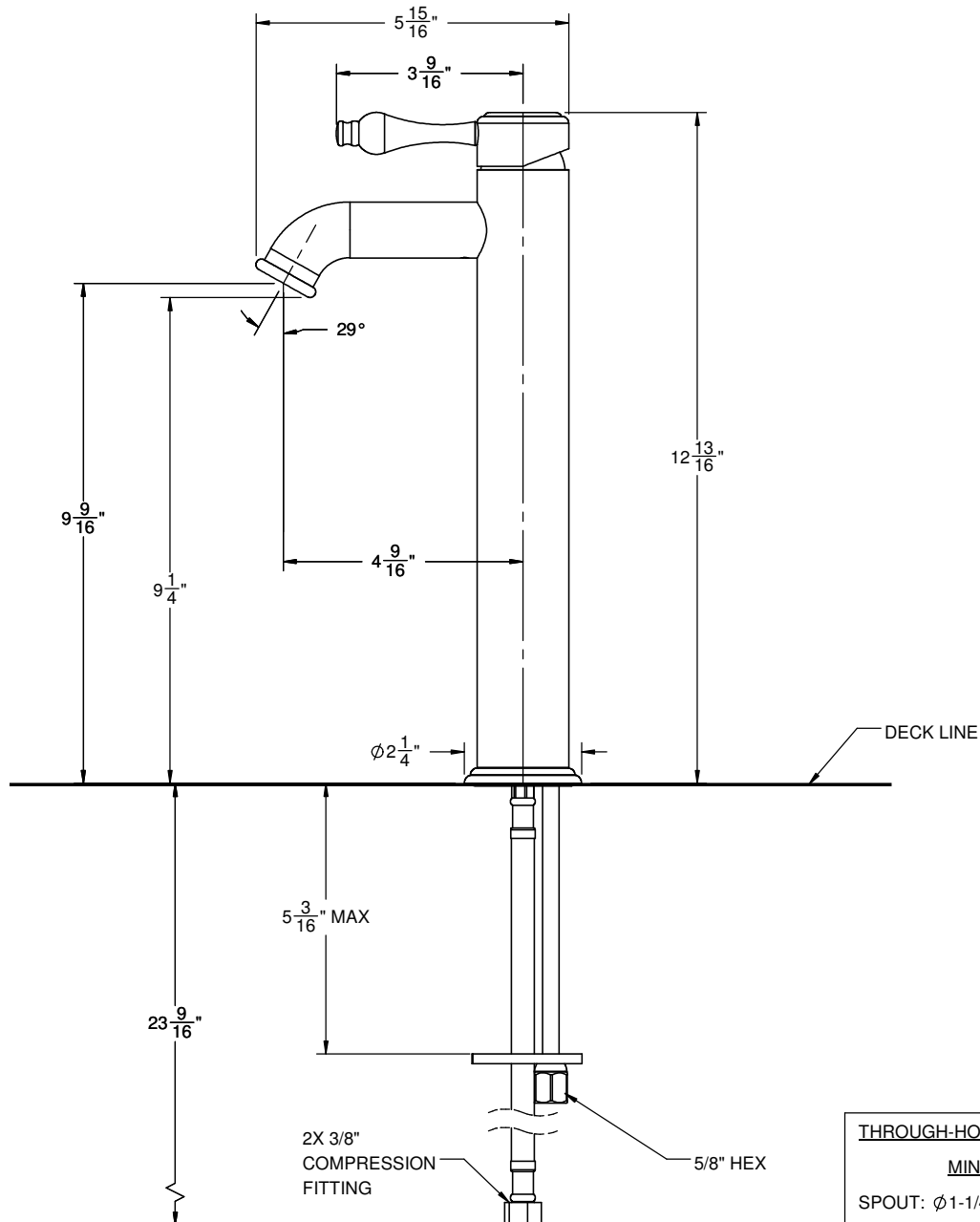

THROUGH-HOLE SPECIFICATIONS	
MIN	RECOMMENDED
SPOUT: $\phi 1 \frac{1}{4}$ "	$\phi 1 \frac{3}{8}$ "

ALL DIMENSIONS SHOWN TO NEAREST 1/16"



California Faucets®

Huntington™

SINGLE HOLE LAV / VESSEL / BAR FAUCET

CF-4201-2-H33

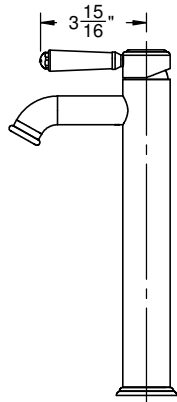
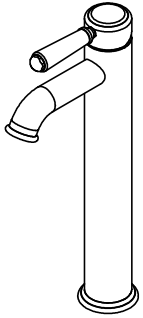

CF-4201-2-H35

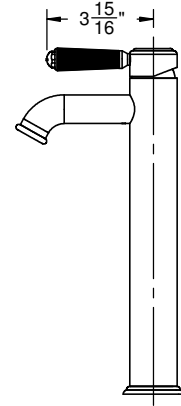
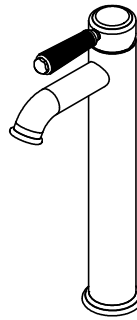

CF-4201-2-H40

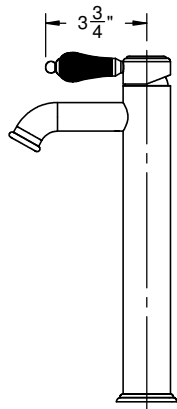
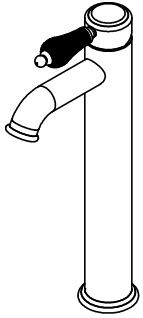

CF-4201-2-H55

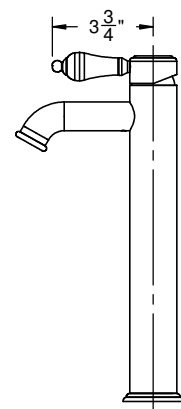
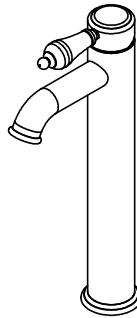

CF-4201-2-H64

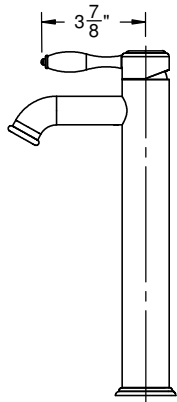
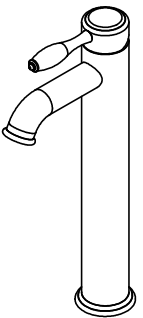

CF-4201-2-H68

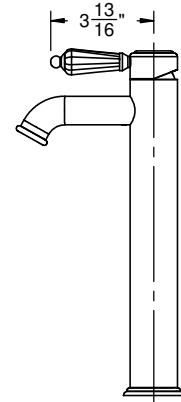
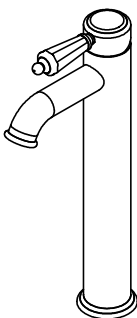

CF-4201-2-CLEV

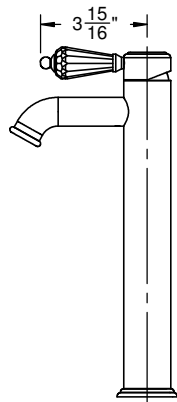
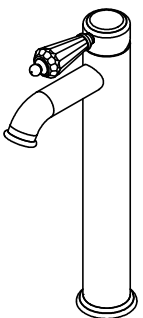

ALL DIMENSIONS SHOWN TO NEAREST 1/16"