

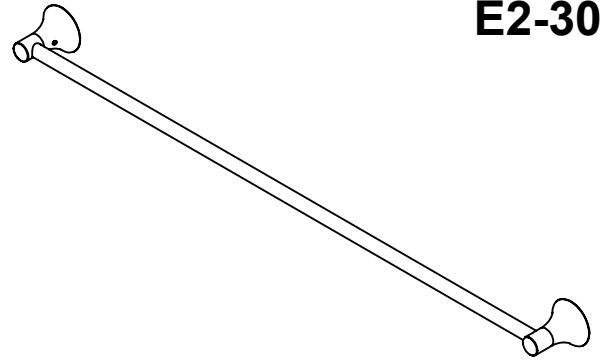

E2-30

Features

- Over 30 finishes including 14 PVD finishes
- Solid brass construction
- Includes mounting hardware
- For additional product offerings, see www.californiafaucets.com



Codes/Standards Applicable

Meets or exceeds the following at date of manufacture:

- None applicable

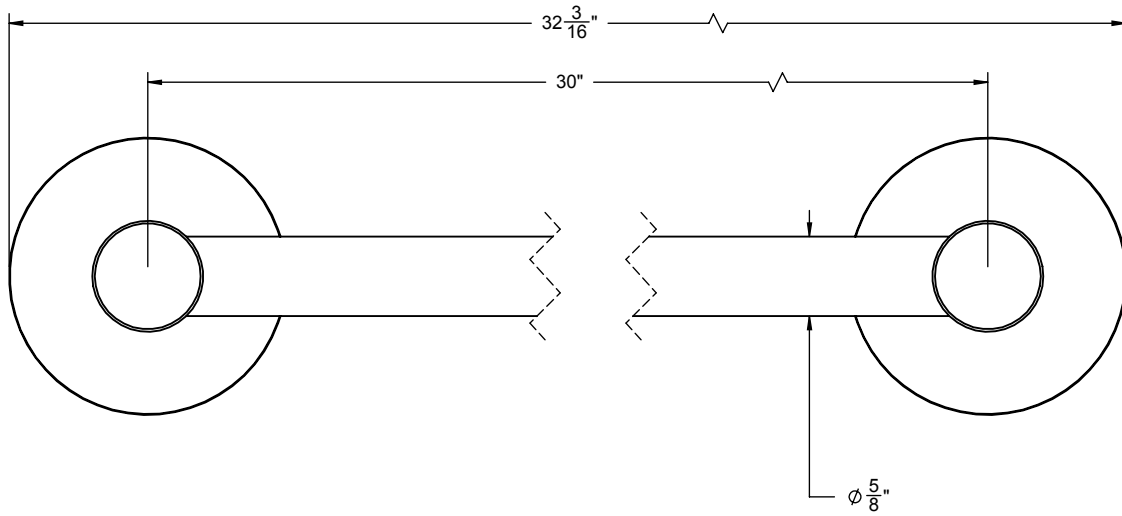

(4X) 1X3/8" ANCHOR



(4X) 8X1/2" PHILLIPS HEAD SCREW

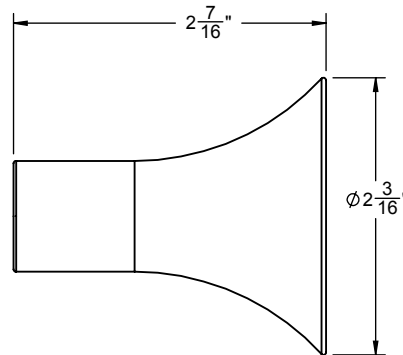

ALL DIMENSIONS SHOWN TO NEAREST 1/16"