



California Faucets®

# Showerhead

3-1/2" 8 JETS

## Features

- 1/2" FIP inlet
- Brass construction
- 3-1/2" diameter
- Replace .FR with desired max flow rate:  
SH-05.25 for 2.5 gpm  
SH-05.20 for 2.0 gpm  
SH-05.15 for 1.5 gpm



SH-05.25  
SH-05.20  
SH-05.15  
SH-05  
WE-SH-05

## Codes/Standards Applicable

Product meets or exceeds the following:

- ASME A112.18.1/CSA B125.1
- CEC (2.0 and 1.5 gpm)

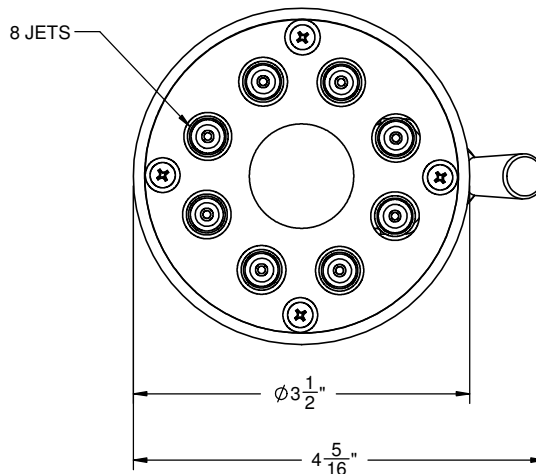
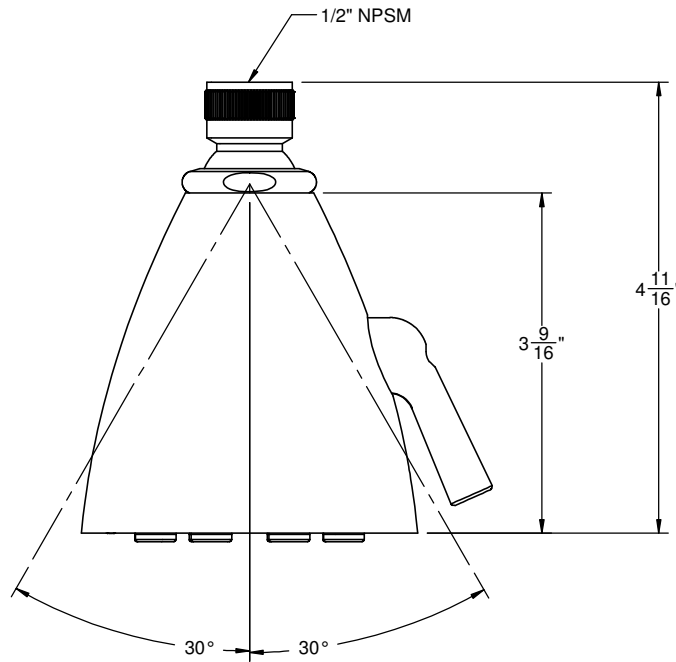

ALL DIMENSIONS SHOWN TO NEAREST 1/16"