

BALBOA 15 SERIES

"1503-D"



All California Faucets lever and blade handle products are American Disability Act (ADA) compliant.

California Faucets reserves the right to make modification and specification changes at any time. Please verify dimensions prior to installation. Visit www.calfaucets.com for most current technical data.

Front View

Flow rate = 10 GPM @ 60 PSI

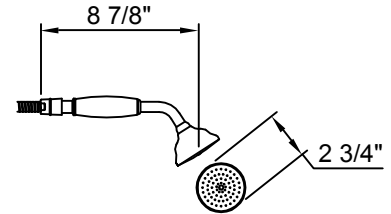
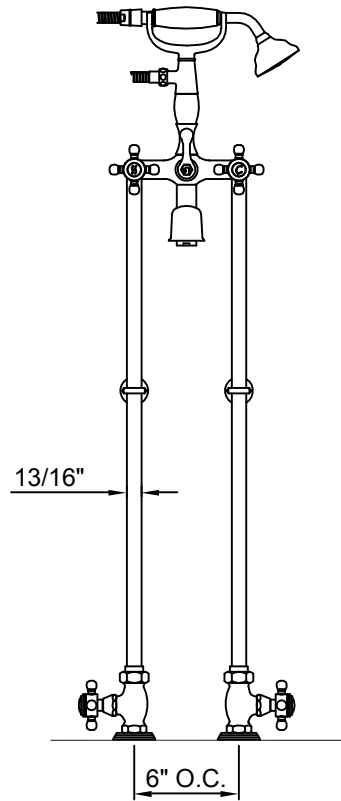

Handshower

Side View

