



### Features

- Over 30 finishes including 14 PVD finishes
- Solid brass construction
- Adjustable spray plunges allows fine, gentle or drenching sprays
- 8 plunger jets produce 64 individual spray streams
- 3-1/2" face diameter
- 1/2" FIP swivel inlet
- 2.5 gpm (9.5 Lpm) max flow rate
- Order **WE** for 2.0 gpm (7.6 Lpm) max flow rate



**SH-05**  
**WE-SH-05**

### Codes/Standards Applicable

Meets or exceeds the following at date of manufacture:

- ASME A112.18.1/CSA B125.1

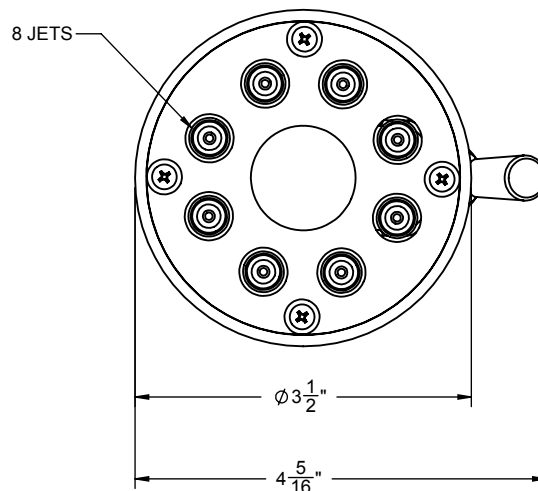
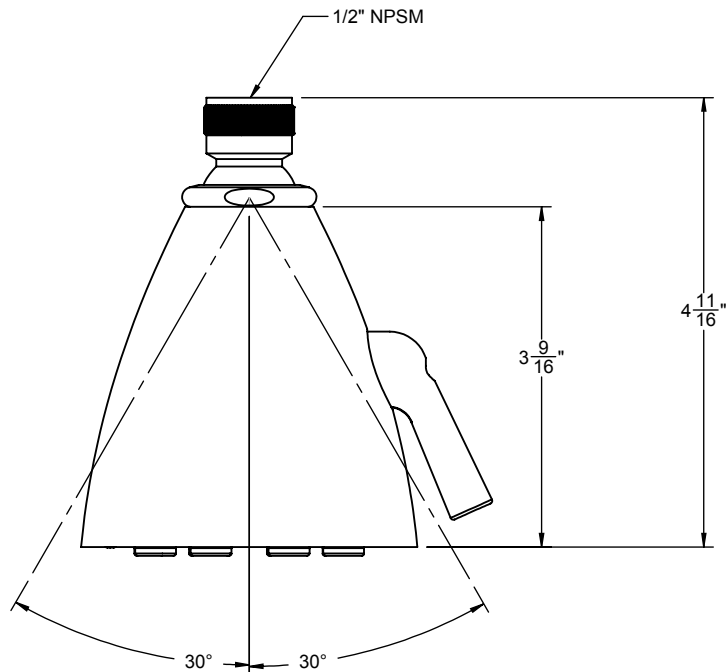

ALL DIMENSIONS SHOWN TO NEAREST 1/16"